

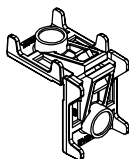

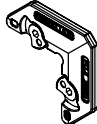

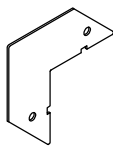

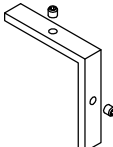
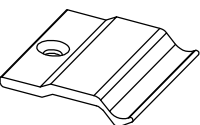
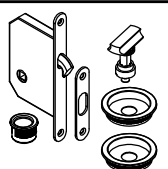
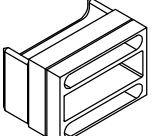

Porte interne a scomparsa

ACCESSORI	CODICE	DESCRIZIONE	UNITA'	MATERIALI
	LM0200	Squadretta di giunzione angolare con pulsanti di ancoraggio rivolti all'interno, vite di serraggio a filettare sull'alluminio. L 35.9 x H 13.8	250	alluminio pressofuso
	LM2000	Squadretta di allineamento con eccentrici rivolti all'esterno, vite di serraggio a dado. L 28.5 x H 34.6	250	alluminio pressofuso
	SA0274210	Squadretta di allineamento anta	50	acciaio
	EK16026L	Squadretta di giunzione imbotti con grani di fissaggio	200	alluminio
	EP4685399	Clips per fissaggio profilati imbotte	100	nylon
	66048718813	Kit serratura e Maniglia ad incasso	1	
	FRVAPI00113	Tappi fissaggio zoccolo	???	nylon
	IS915986	Guarnizione battuta interna antiacustica e parapolvere	Bobine da 250 ml	EPDM 60 Sh
	PB69x900	Spazzolino	???	Polipropilene
	PB69x1200	Spazzolino	???	Polipropilene

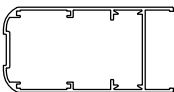
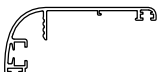
Porte interne a scomparsa

Y PROFILATO X	CODICE	DESCRIZIONE	Gr/ml	SUP. IN VISTA mm	PERIM. ESTERNO mm	Jx cm ⁴	Jy cm ⁴
	5PI00113	Fascia H 120mm	1395	248	391	72,64	18,24
	5PI00114	Anta	1257	222	296	16,46	39,59
	5PI00115	Imbotte 35mm	744	111	346	3,60	18,24
	5PI00116	Telaio per imbotte	307	--	147	0,66	0,26
	5PI00117	Telaio battuta anta	602	63	278	16,90	1,07
	5PI00118	Riporto portaspazzolini	289	26	177	0,24	1,21
	5PI00119	Riporto per vetro semplice	262	30	158	0,27	1,10
	5PI00120	Imbotte 42mm	794	115	368	5,73	18,58

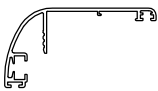
Porte interne a scomparsa

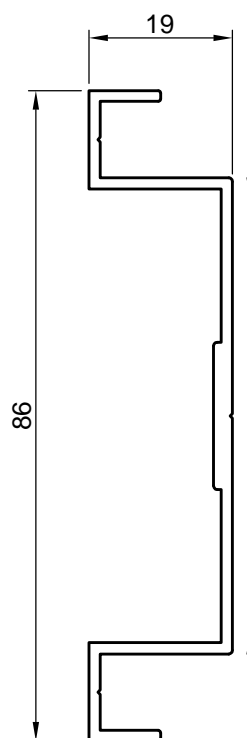

5PI00117

Gr/ml 602

Sup. in vista 63 mm.

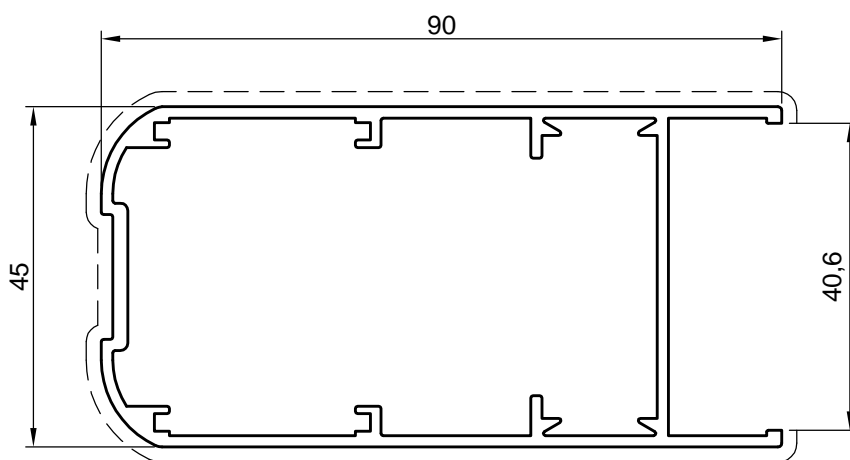

5PI00114

Gr/ml 1257

Sup. in vista 222 mm.

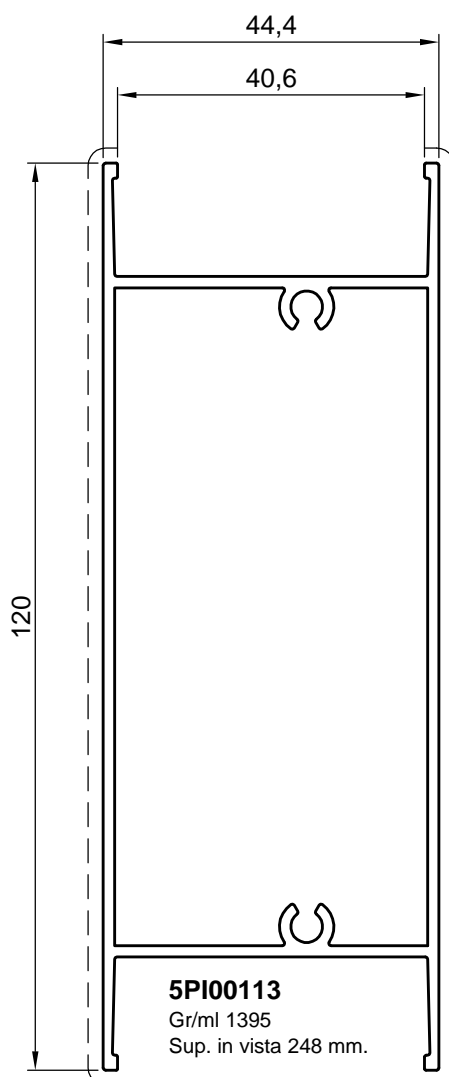

5PI00113

Gr/ml 1395

Sup. in vista 248 mm.

Porte interne a scomparsa

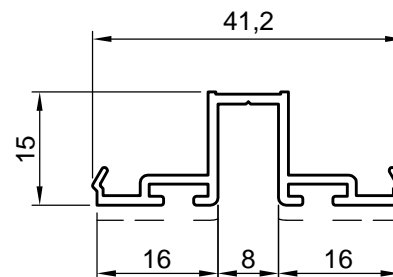
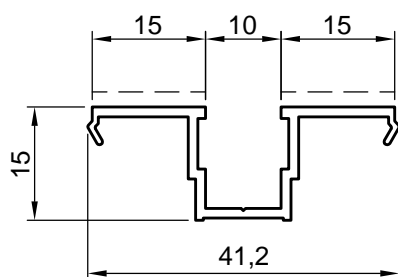
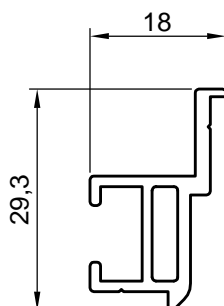
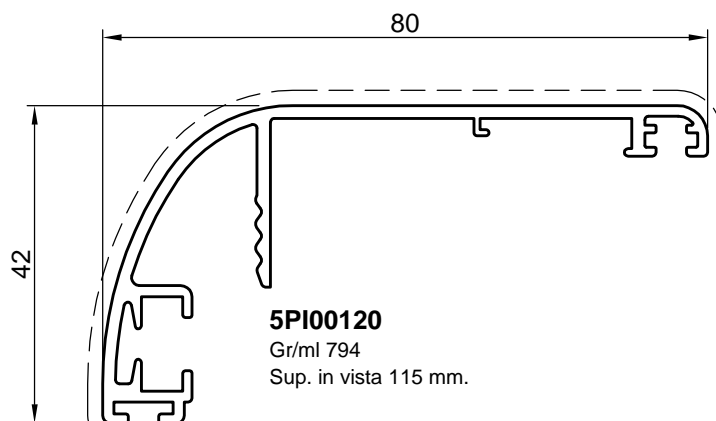
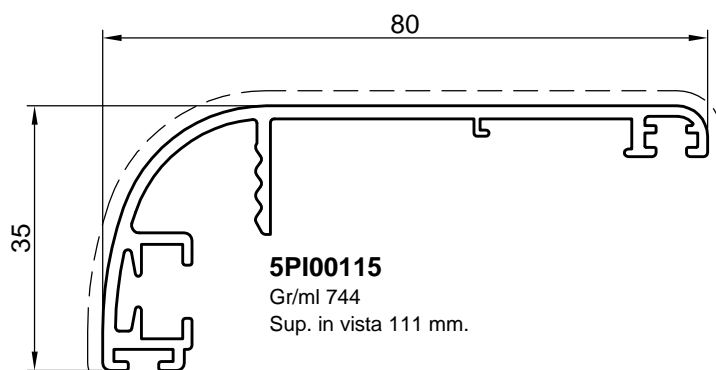

Porte interne a scomparsa

Nodo Laterale Pannello

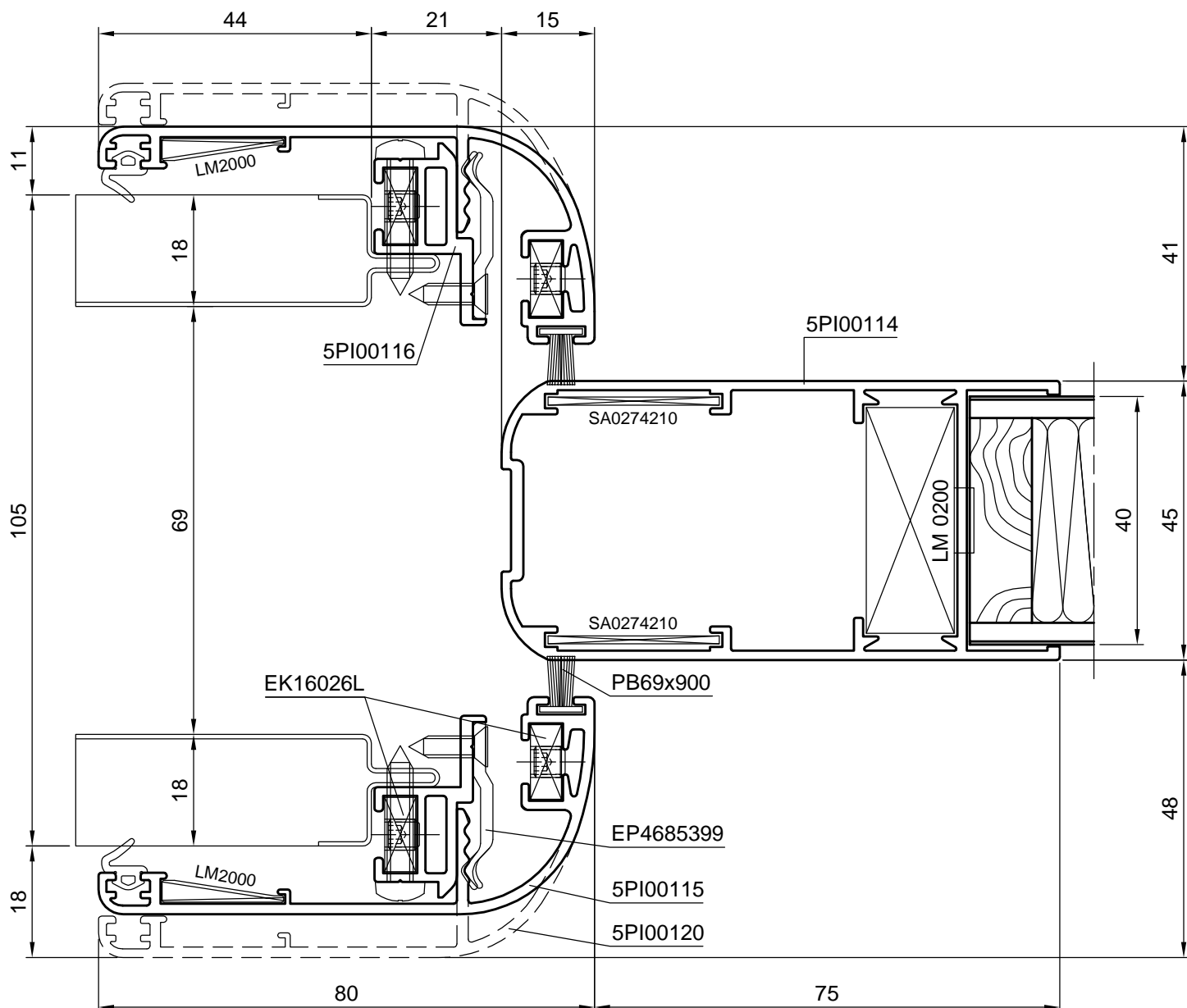
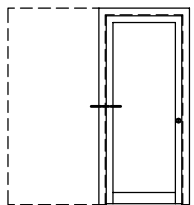

Porte interne a scomparsa

Nodo Laterale Pannello

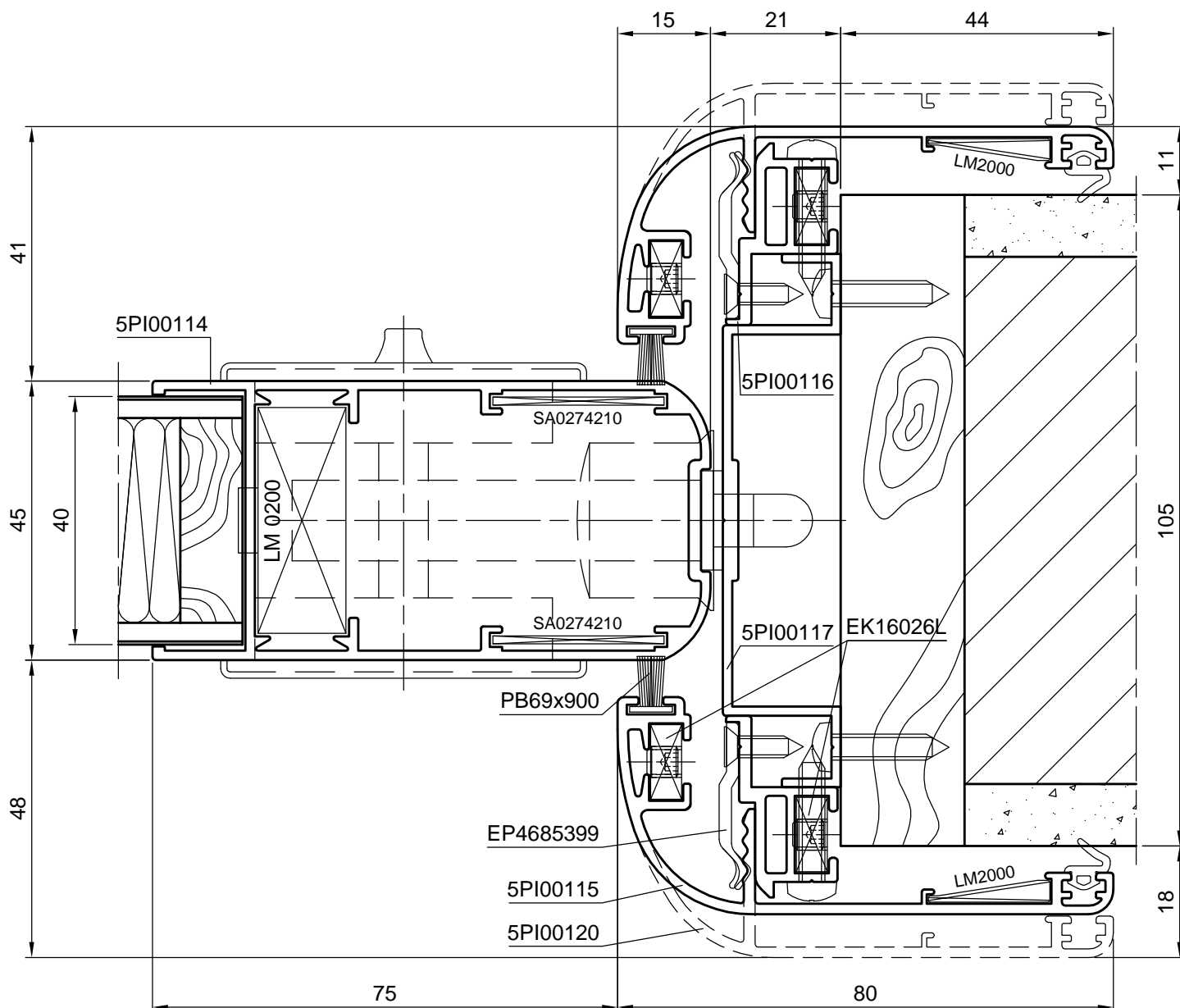
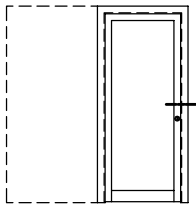

Nodo Superiore Pannello

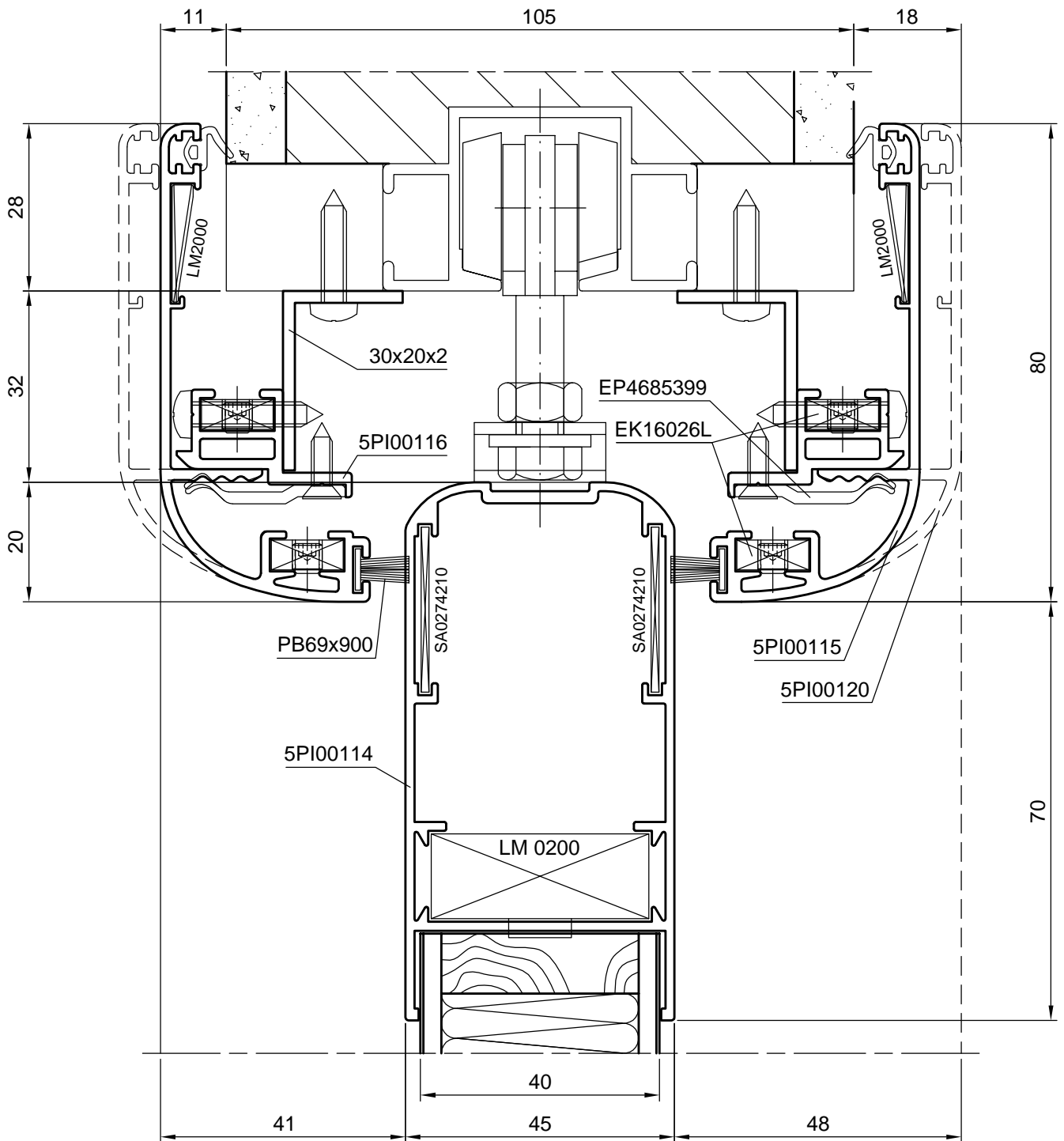
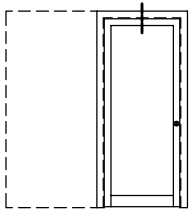

Porte interne a scomparsa

Nodo Inferiore Pannello

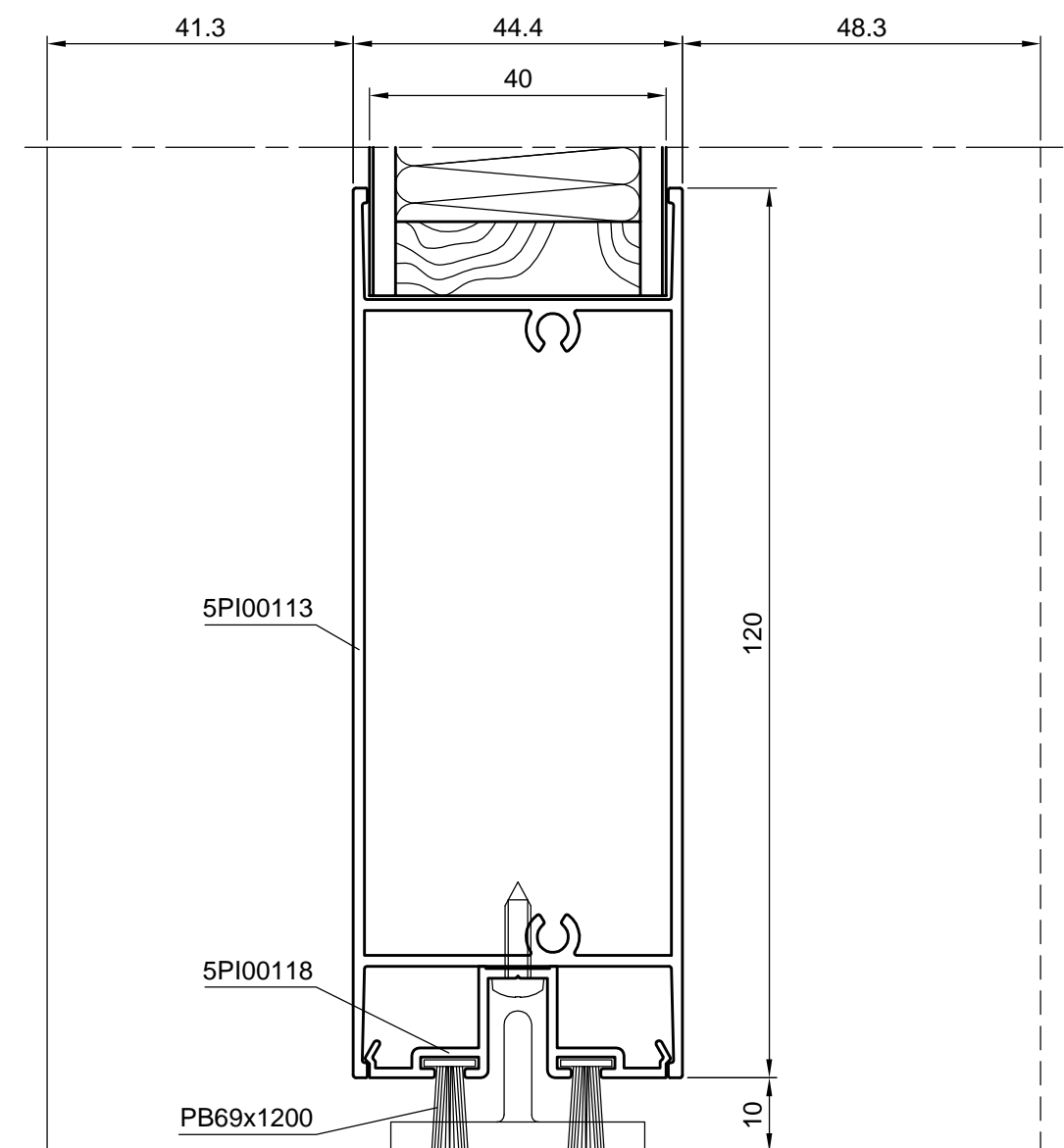
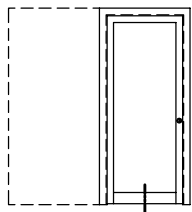

Porte interne a scomparsa

Nodo Laterale Vetro

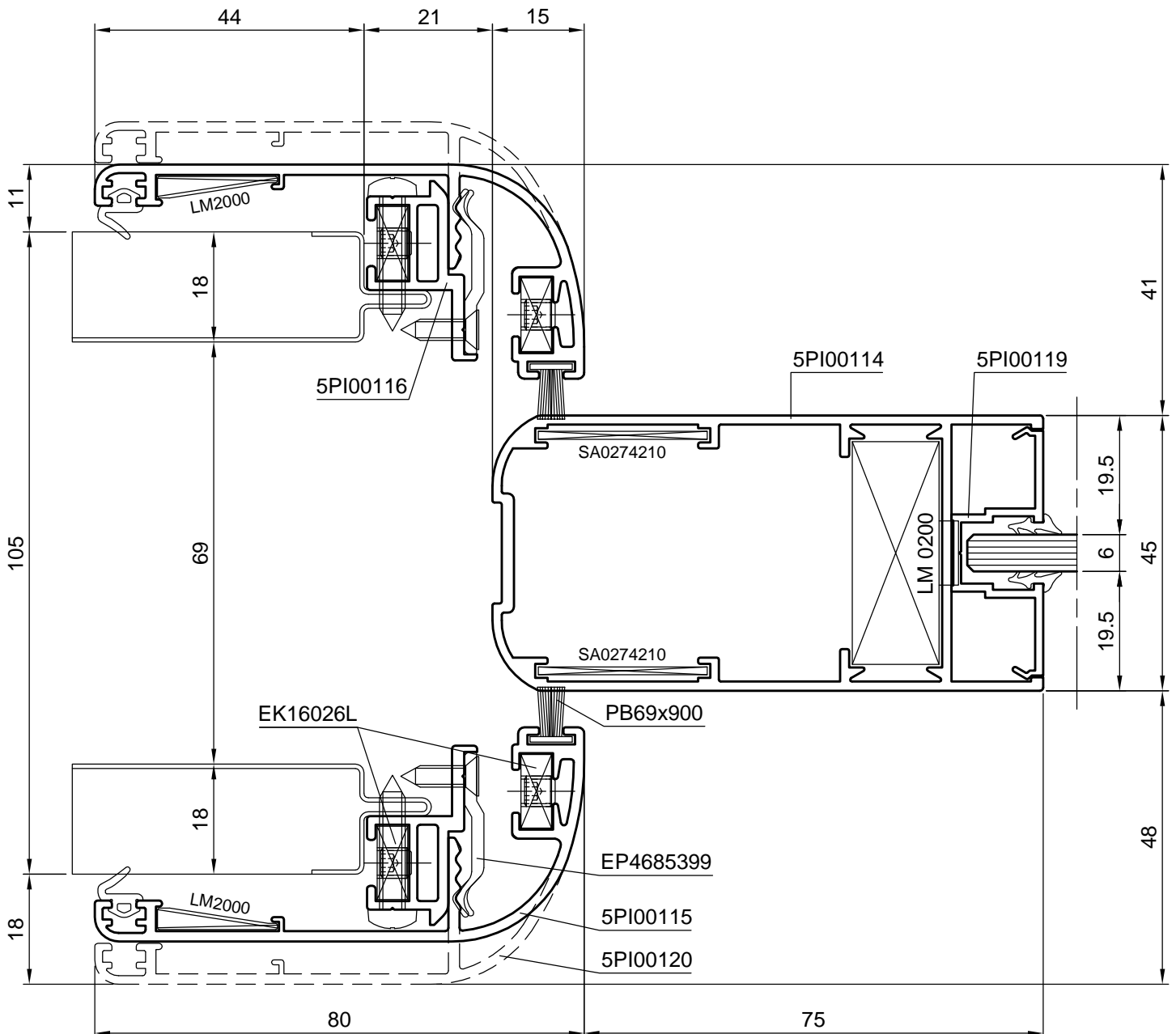
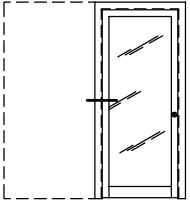

Porte interne a scomparsa

Nodo Laterale Vetro

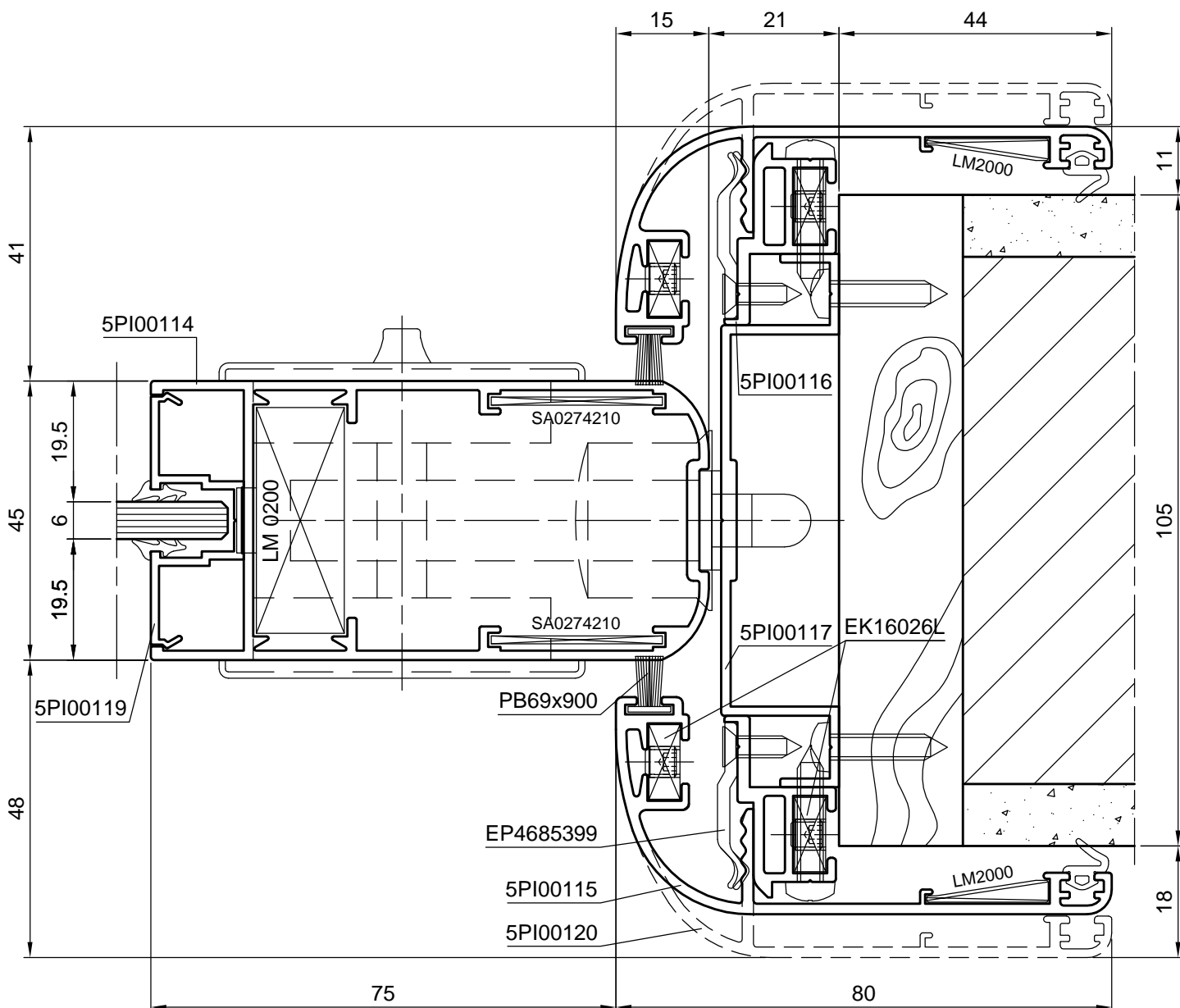
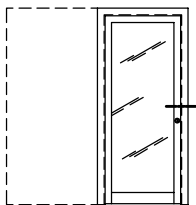

Porte interne a scomparsa

Nodo Superiore Vetro

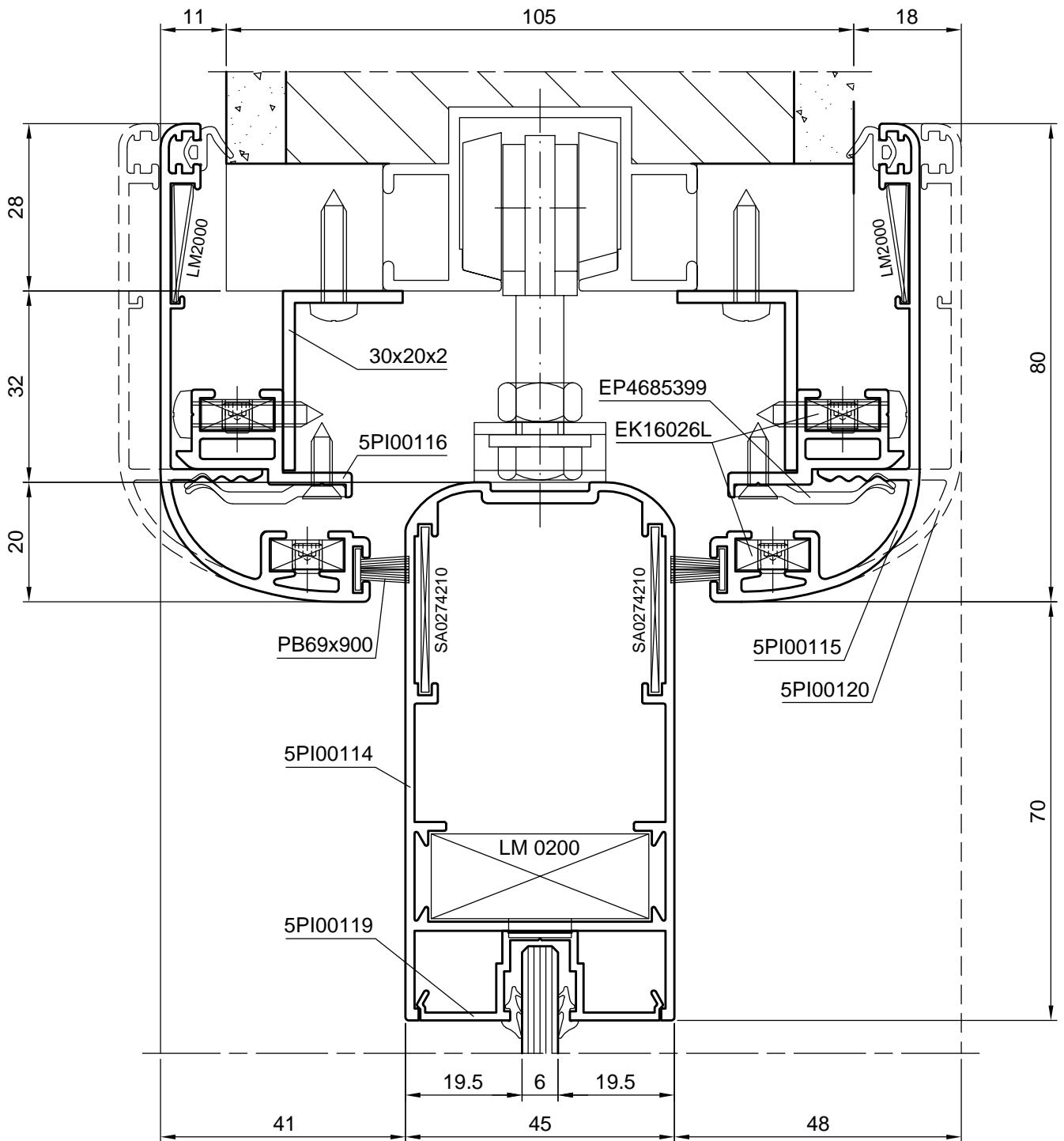
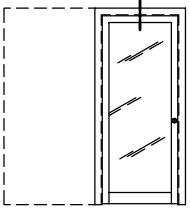

Porte interne a scomparsa

Nodo Inferiore Vetro

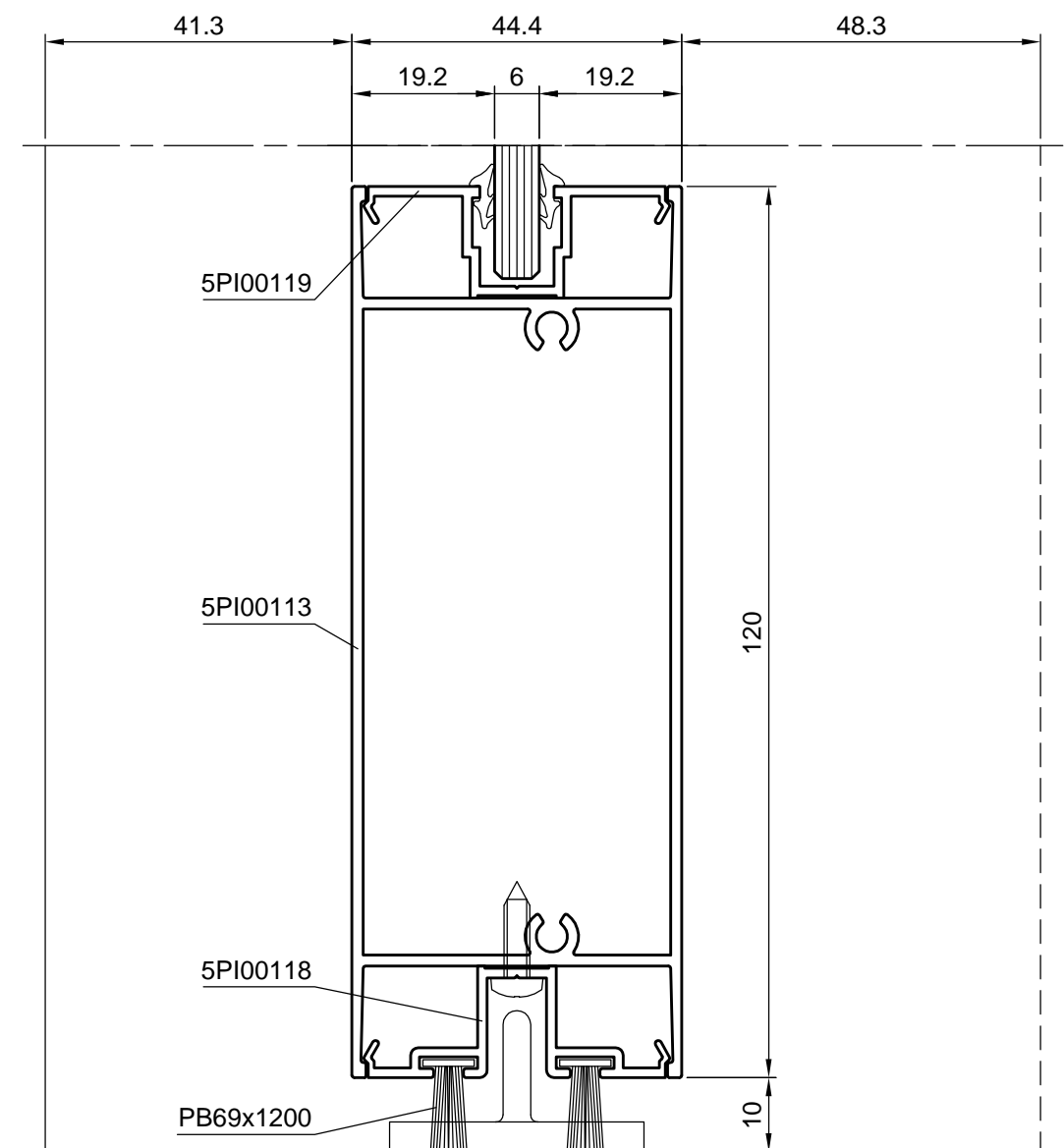
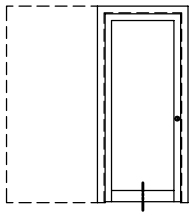

Porte interne a scomparsa

PORTA 1 ANTA

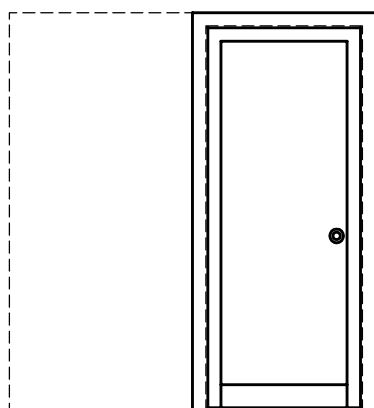

PROFILATI

CODICE	DESCRIZIONE	PEZZI	TAGLIO
5PI00115	Montante Imbotte	4	H + 28
5PI00115	Traverso Imbotte	2	L + 99
5PI00116	Montante Telaio Imbotte	4	H - 42
5PI00116	Traverso Telaio Imbotte	2	L - 31
5PI00117	Montante Battuta Anta	1	H
5PI00114	Montante Anta	2	H - 42
5PI00114	Traverso Anta	1	L - 31
5PI00113	Zoccolo	1	L - 211
5PI00118	Portaspazzolini	1	L - 38
	Profirato L standard 25x15x2	2	2L

ACCESSORI

CODICE	DESCRIZIONE	PEZZI
LM0200	Squadretta Pressofusa a scatto	2
SA0274210	Squadretta di allineamento	4
LM2000	Squadretta di allineamento con eccentrici	4
EK16026L	Squadretta per imbotte e telaio imbotte	8
EP4685399	Clips per aggancio imbotte	(L+H)/300
6GM98718813	Kit serratura e maniglia	1

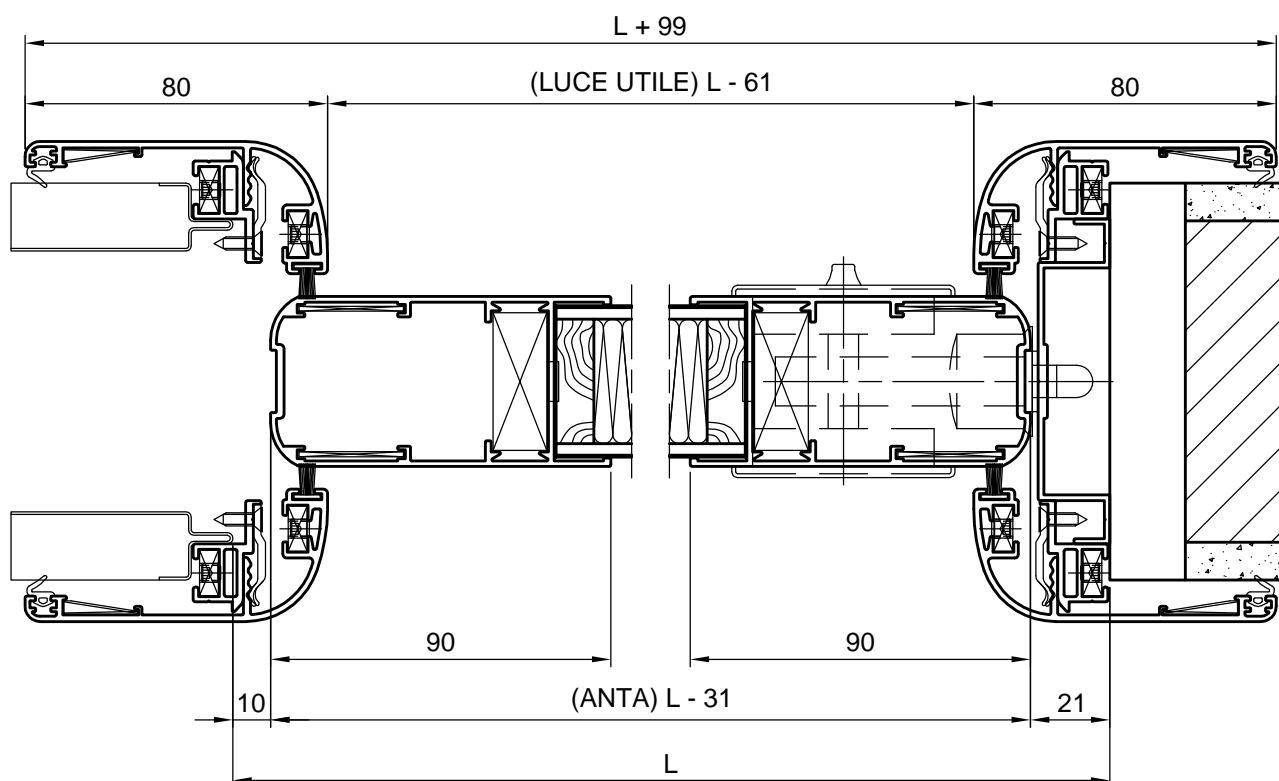

Porte interne a scomparsa

GUARNIZIONI

CODICE	DESCRIZIONE	PEZZI	TAGLIO
IS915986	Guarnizione di battuta	1	$(4H + 2L) + 200$
PB69x900	Spazzolino	1	$4H + 2L$
PB69x1200	Spazzolino	1	$2L$

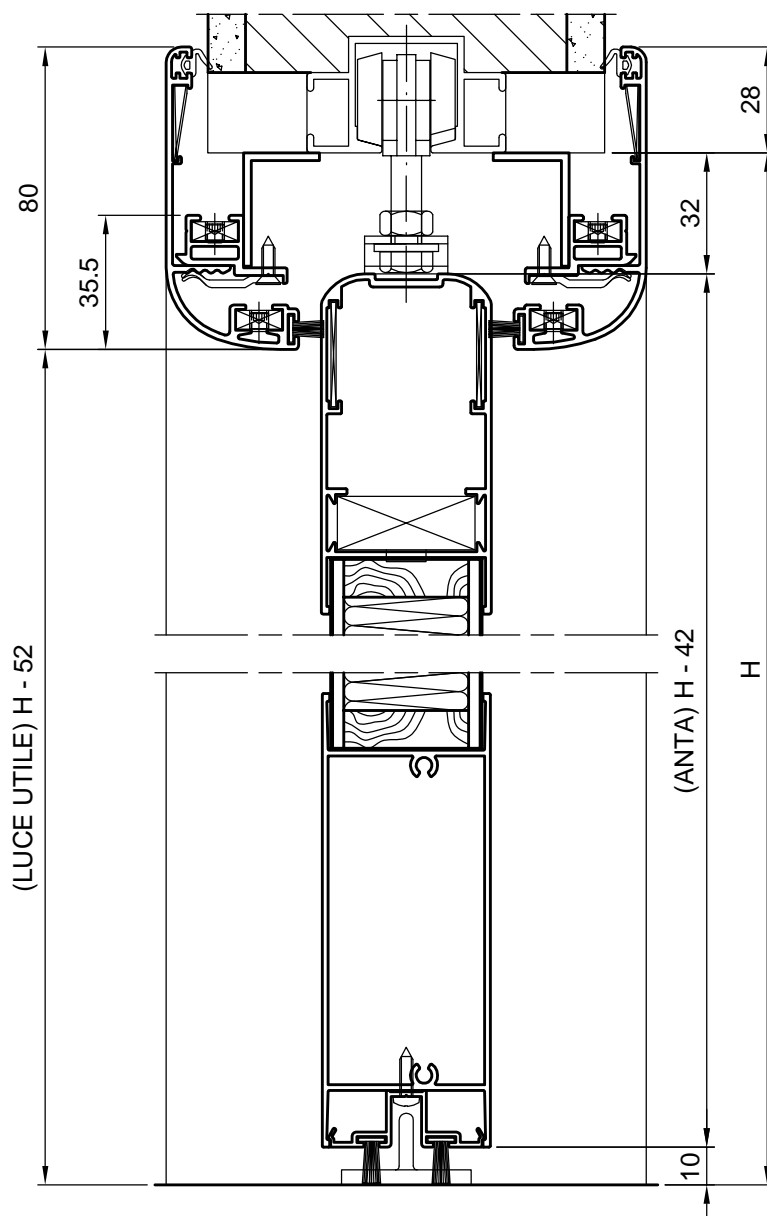

Porte interne a scomparsa

DESCRIZIONE	ACCESSORIO	ATTREZZATURA
- Lavorazione foro-asola per squadretta a bottone in alluminio pressofuso, per anta	LM0200	PERSIANE ALEXIA

SCALA 1:2

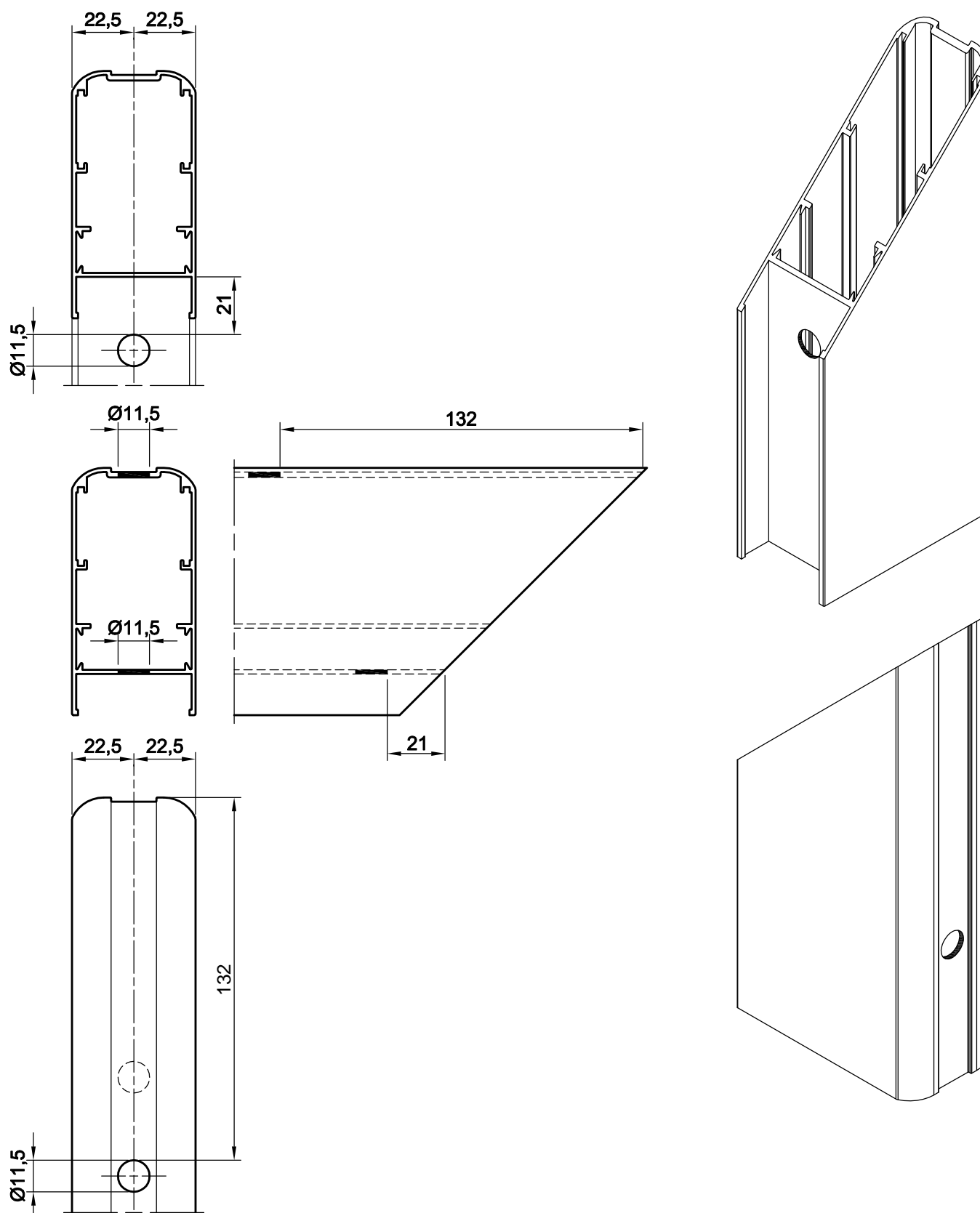

Porte interne a scomparsa

DESCRIZIONE	ACCESSORIO	ATTREZZATURA
- Lavorazione foro fissaggio zoccolo		TRAPANO

SCALA 1:2

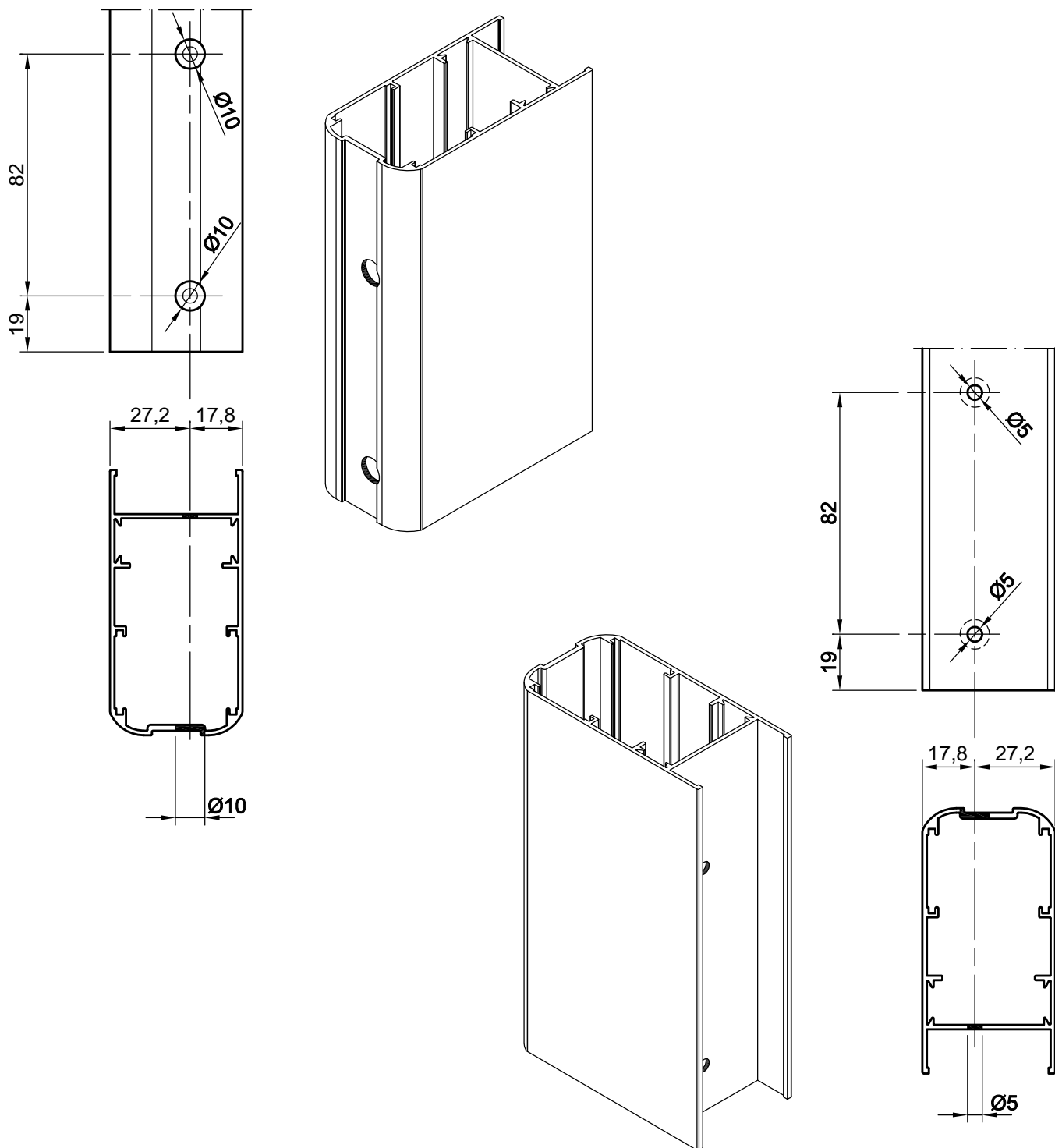

Porte interne a scomparsa

DESCRIZIONE	ACCESSORIO	ATTREZZATURA
- Lavorazione inserimento serratura		TRAPANO

SCALA 1:2

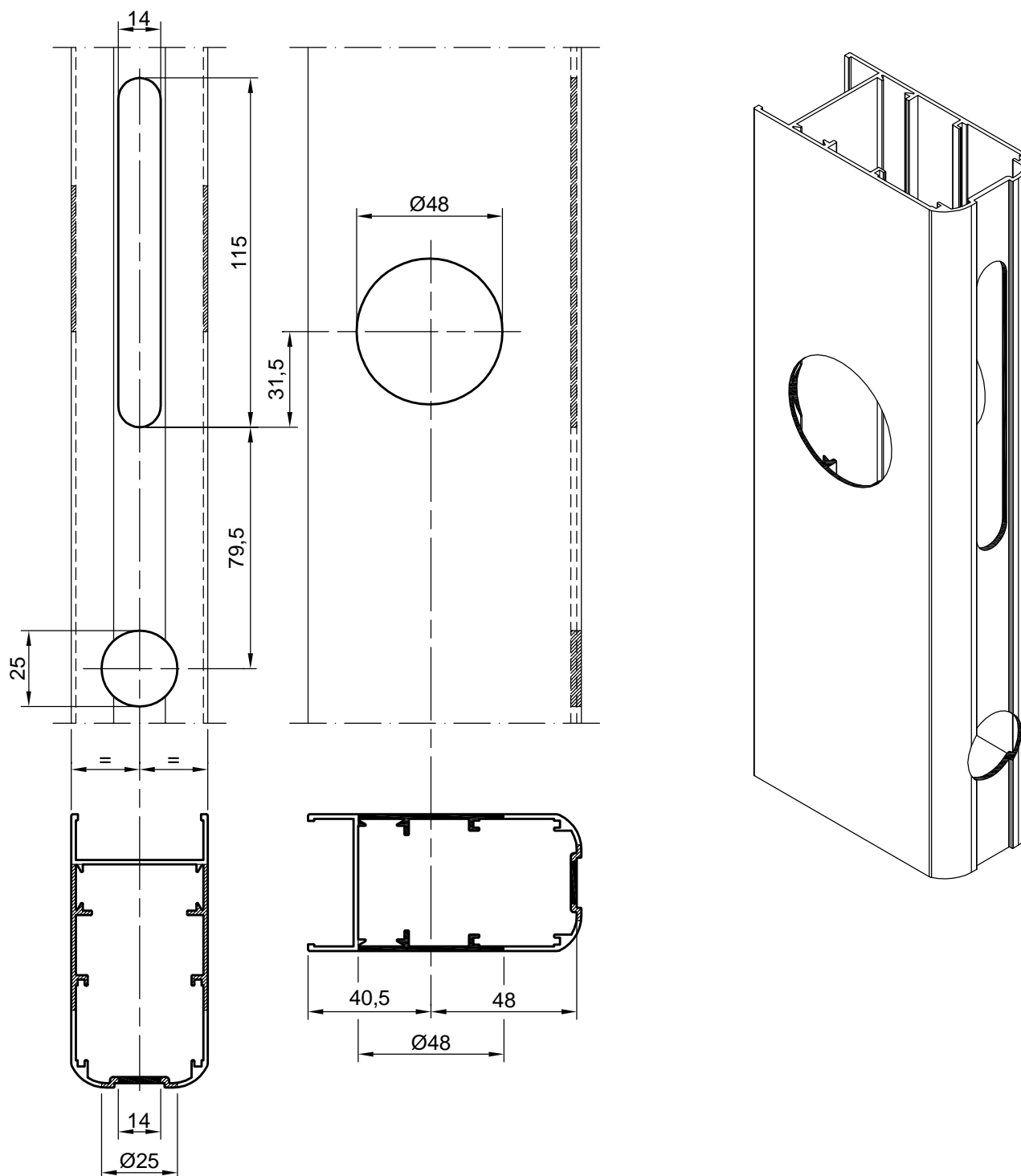

Porte interne a scomparsa

DESCRIZIONE	ACCESSORIO	ATTREZZATURA
- Lavorazione fresatura per assemblaggio portaspazzolini lato serratura		PANTOGRAFO

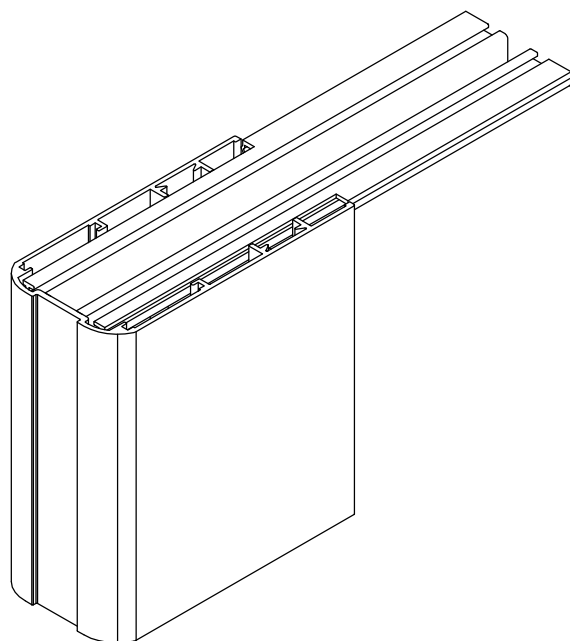
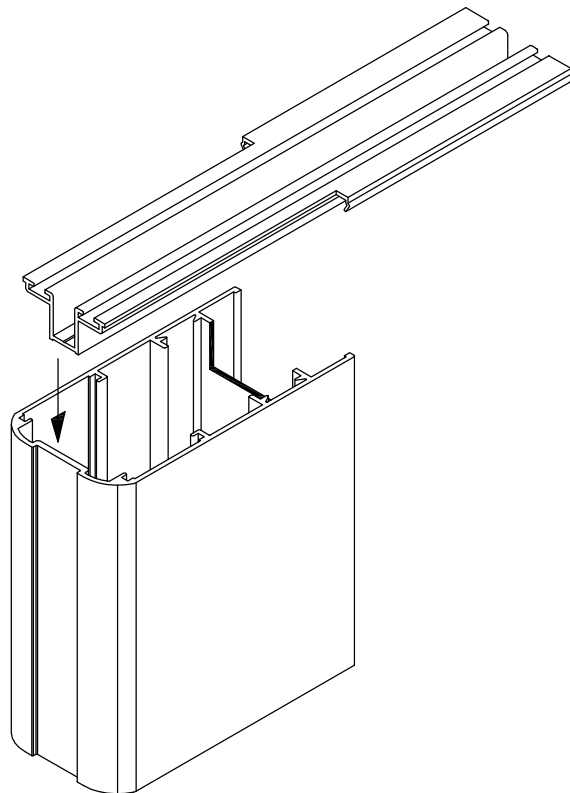
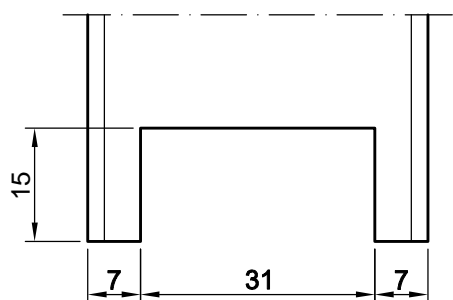
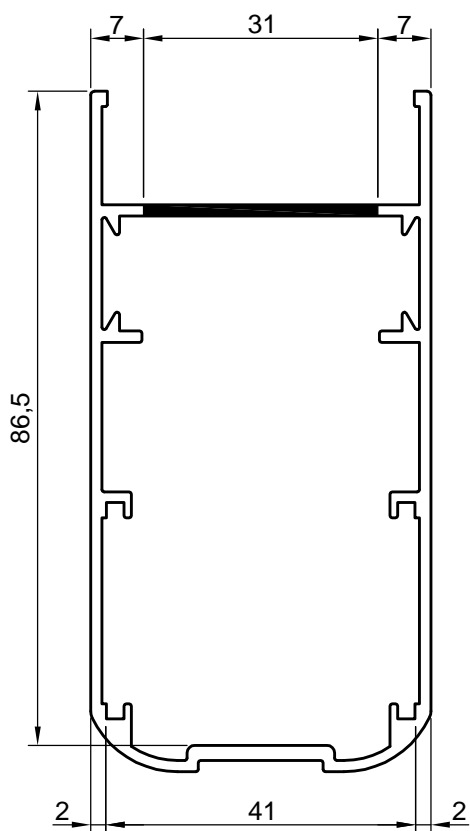

Porte interne a scomparsa

DESCRIZIONE	ACCESSORIO	ATTREZZATURA
- Lavorazione fresatura per assemblaggio portaspaolini lato incasso nel muro		PANTOGRAFO

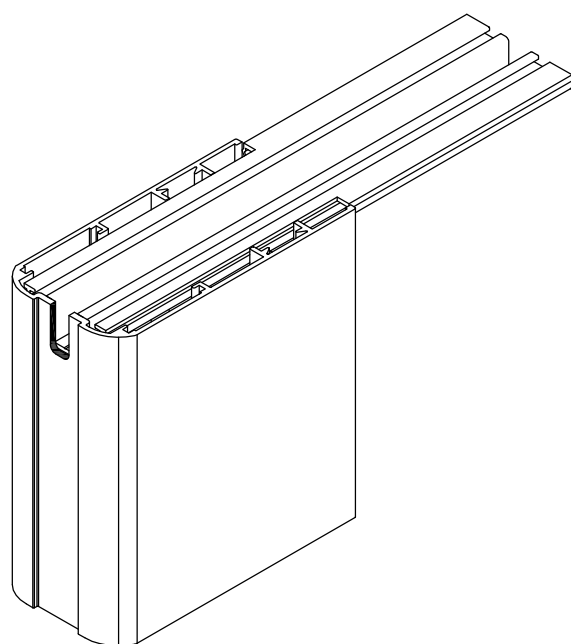
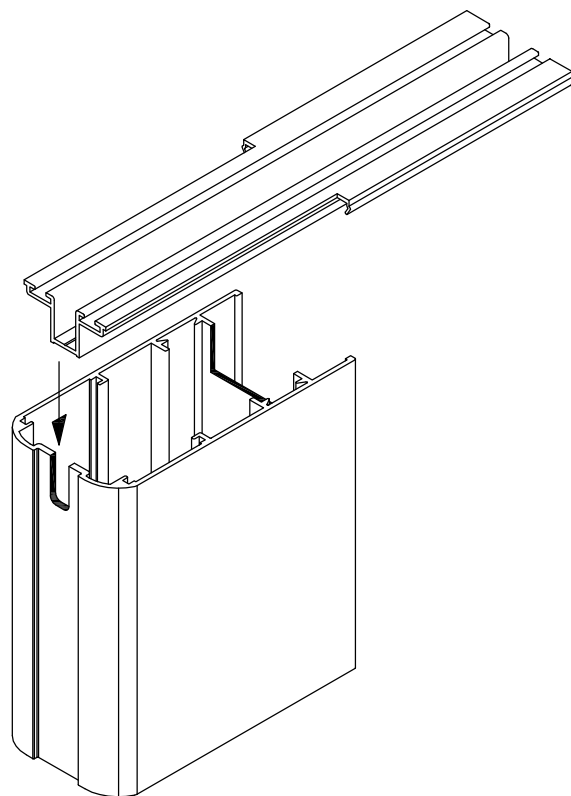
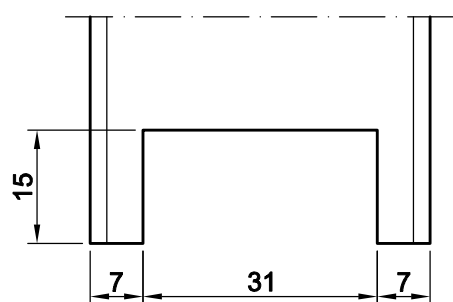
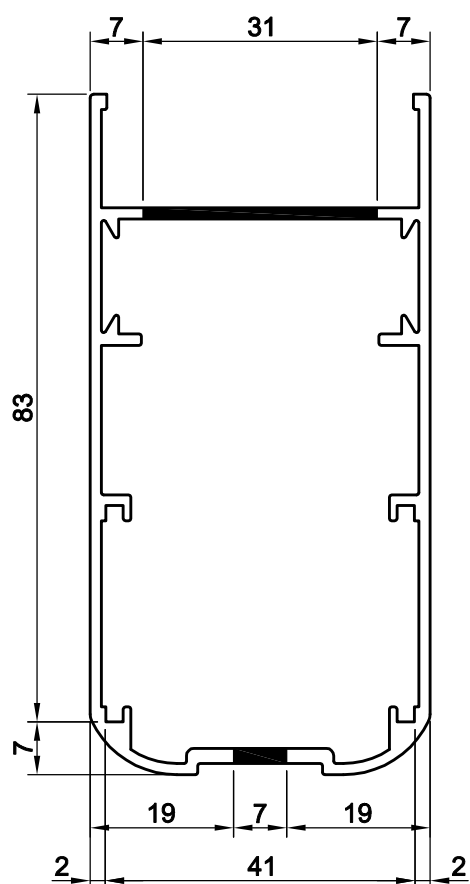
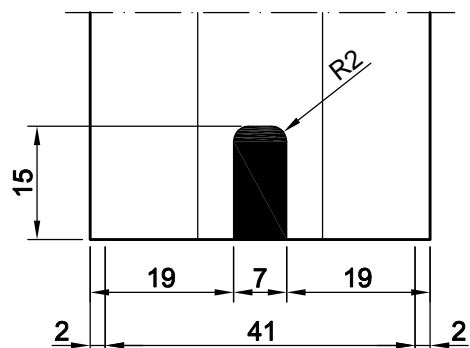

Porte interne a scomparsa

DESCRIZIONE	ACCESSORIO	ATTREZZATURA
- Lavorazione taglio e foratura portaspazzolini		PANTOGRAFO TRAPANO

SCALA 1:2

